

0.4mm Pitch, 0.98/1.5mm Mated Height, Board-to-Board / Board-to-FPC Connectors

DF37 Series

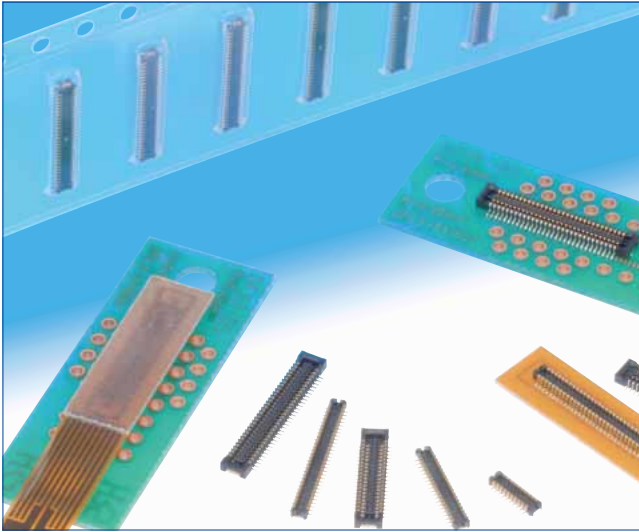

Further reduction of the board space.

Comparison of board mounting space

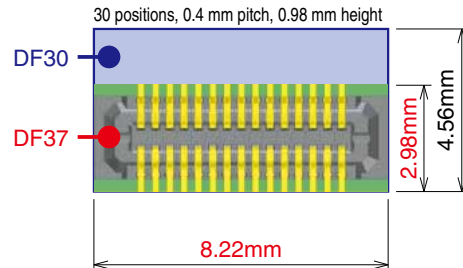

Fig.1

Features

1. Reduced size and board-occupied area

With the mated height of 0.98/1.5mm, width of 2.98mm and length of 8.22mm (30 positions) the connectors are one of the smallest in its class. Also 2.6mm depth short-lead type is available. (Fig.1)

Sufficiently large flat areas allow pick-up with vacuum nozzles of automatic placement equipment.

2. Reliable electrical and mechanical connection

Despite its small mated height, unique contact configuration, with a 2-point contacts and effective mating length of 0.25mm, assures highly reliable connection while confirming a complete mating with a definite tactile feel.

3. Self alignment

Recognizing the difficulties of mating extremely small connectors in limited spaces, the connectors will self-align within 0.3mm.

4. Physical shock and vibration protection

2-point contact assures electrical connection in a shock or vibration applications. (Fig.2)

5. Solder wicking prevention

Nickel barriers (receptacles) and unique forming of the contacts (headers) prevent un-intentional solder wicking.

6. Contamination protection

Insulator walls protect the contact areas against flux splatter or other physical particles contamination. (Fig.3)

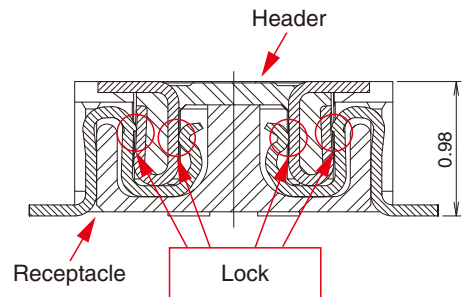
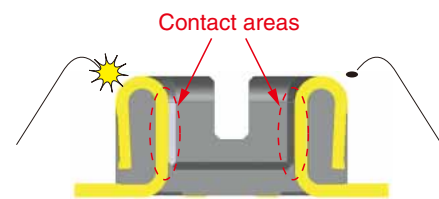

Fig.2

Splatter protection



Contact areas are not exposed to the outside penetration of the flux or other physical particles.

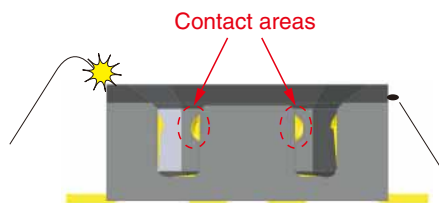

Fig.3

Product Specifications

Ratings	Current rating	0.3A	Operating temperature range	-35°C to +85°C (Note 1)	Storage temperature range	-10°C to +60°C (Note 2)
	Voltage rating	30V AC, DC	Operating humidity range	RH 20% to 80%	Storage humidity range	RH 40% to 70% (Note 2)

Item	Specification	Conditions
1. Insulation resistance	50MΩ min	100V DC
2. Withstanding voltage	No flashover or insulation breakdown	100V AC / 1minute
3. Contact resistance	100mΩ max.	20mV AC, 1kHz, 1mA
4. Vibration	No electrical discontinuity of 1μs or longer No damage or parts dislocation	Frequency : 10 to 55 Hz, single amplitude of 0.75 mm, 2 hours, 3 axis
5. Humidity	Contact resistance : 100mΩ max., Insulation resistance : 25MΩ min.	96 hours at 40 ±2°C and humidity of 90 to 95% No damage or parts dislocation
6. Temperature cycle	Contact resistance : 100mΩ max., Insulation resistance : 50MΩ min. No damage or parts dislocation	-55°C → 5 to 35°C → 85°C → 5 to 35°C Time: 30 min. → 10 min. → 30 min. → 10 min. 5 cycles
7. Durability	Contact resistance : 100mΩ max.	10 cycles
8. Resistance to soldering heat	No deformation of components affecting performance	Reflow : At the recommended temperature profile Manual soldering : 350°C for 3 seconds

Note 1 : Includes temperature rise caused by current flow.

Note 2 : The term "storage" here refers to products stored for a long period prior to board mounting and use.

The operating temperature and humidity range covers the non-conducting condition of connectors after board mounting and the temporary storage conditions of transportation, etc.

Materials / Finish

Receptacle

Part	Material	Finish	Remarks
Insulator	LCP	Color: Black	UL94V-0

Header

Part	Material	Finish	Remarks
Contacts	Phosphor bronze	Gold plated	_____

Product Number Structure

Refer to the chart below when determining the product specifications from the product number.

Please select from the product numbers listed in this catalog when placing orders.

●Receptacles

DF 37 # - (*) - * DS - 0.4 V (***)**

①
②
③
④
⑤
⑥
⑦
⑧

① Series name : DF37	⑤ Connector style DS : Receptacle
② Configuration NB : With metal fittings NC : Without metal fittings SB : Short-lead type with metal fittings	⑥ Contact pitch : 0.4mm
③ Stacking height Blank : 0.98mm, 1.5 : 1.5mm	⑦ Terminal type V : SMT vertical mount
④ Number of contacts	⑧ Packaging (51) Stacking height 0.98mm : Embossed tape packaging (8,000 pcs/reel) (51) Stacking height 1.5mm : Embossed tape packaging (5,000 pcs/reel) (53) : Embossed tape packaging (1,000 pcs/reel)

●Headers

DF 37 # - * DP - 0.4 V (*)**

①
②
③
④
⑤
⑥
⑦

① Series name : DF37	④ Connector style DP : Header
② Configuration B : With metal fittings C : Without metal fittings	⑤ Contact pitch : 0.4mm
③ Number of contacts	⑥ Terminal type V : SMT vertical mount
	⑦ Packaging (51) : Embossed tape packaging (8,000 pcs/reel) (53) : Embossed tape packaging (1,000 pcs/reel)

Note : The short-lead type is only available for the receptacle side (with hardware).

■ Receptacles (Stacking Height=0.98mm)

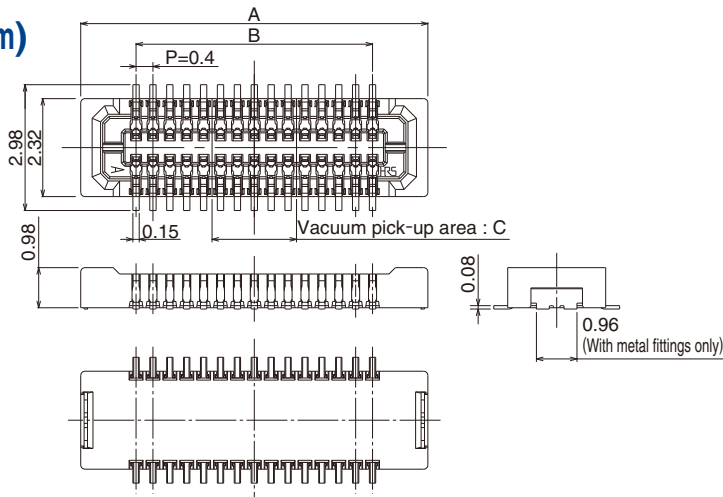

◆ Recommended metal mask dimensions

With metal fittings

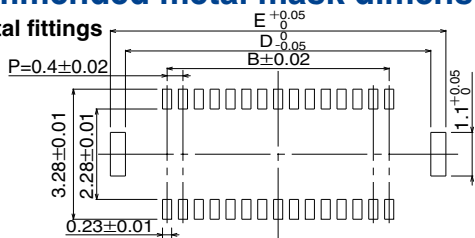

Without metal fittings

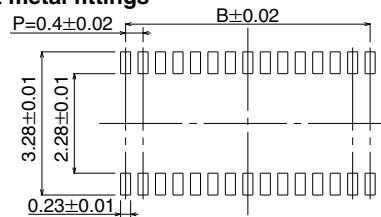

◆ Recommended PCB mounting pattern

With metal fittings

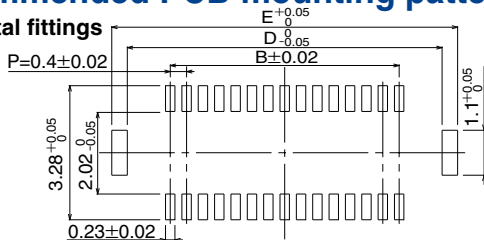

Without metal fittings

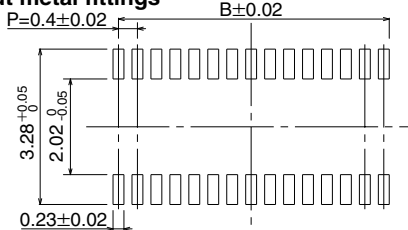

● With metal fittings

Unit : mm

Part No.	HRS No.	No. of Contacts	A	B	C	D	E
DF37NB-10DS-0.4V(51)	684-3301-6 51	10	4.22	1.6	0.8	3.7	4.46
DF37NB-16DS-0.4V(51)	684-3302-9 51	16	5.42	2.8	1.2	4.9	5.66
DF37NB-20DS-0.4V(51)	684-3303-1 51	20	6.22	3.6	1.6	5.7	6.46
DF37NB-24DS-0.4V(51)	684-3304-4 51	24	7.02	4.4	2	6.5	7.26
DF37NB-30DS-0.4V(51)	684-3305-7 51	30	8.22	5.6		7.7	8.46
DF37NB-34DS-0.4V(51)	684-3082-4 51	34	9.02	6.4	2.4	8.5	9.26
DF37NB-40DS-0.4V(51)	684-3306-0 51	40	10.22	7.6		9.7	10.46
DF37NB-44DS-0.4V(51)	684-3407-7 51	44	11.02	8.4	2.8	10.5	11.26
DF37NB-50DS-0.4V(51)	684-3307-2 51	50	12.22	9.6		11.7	12.46
DF37NB-60DS-0.4V(51)	684-3308-5 51	60	14.22	11.6	3.2	13.7	14.46
DF37NB-70DS-0.4V(51)	684-3409-2 51	70	16.22	13.6	3.6	15.7	16.46

● Without metal fittings

Unit : mm

Part No.	HRS No.	No. of Contacts	A	B	C
DF37NC-10DS-0.4V(51)	684-3309-8 51	10	4.22	1.6	0.8
DF37NC-16DS-0.4V(51)	684-3310-7 51	16	5.42	2.8	1.2
DF37NC-20DS-0.4V(51)	684-3311-0 51	20	6.22	3.6	1.6
DF37NC-24DS-0.4V(51)	684-3312-2 51	24	7.02	4.4	2
DF37NC-30DS-0.4V(51)	684-3313-5 51	30	8.22	5.6	
DF37NC-34DS-0.4V(51)	684-3083-7 51	34	9.02	6.4	2.4
DF37NC-40DS-0.4V(51)	684-3314-8 51	40	10.22	7.6	
DF37NC-44DS-0.4V(51)	684-3324-1 51	44	11.02	8.4	2.8
DF37NC-50DS-0.4V(51)	684-3315-0 51	50	12.22	9.6	
DF37NC-60DS-0.4V(51)	684-3316-3 51	60	14.22	11.6	3.2
DF37NC-70DS-0.4V(51)	684-3084-0 51	70	16.22	13.6	3.6

Note 1 : Tape and reel packaging (8,000 pcs/reel). Order by number of reels.

Note 2 : This connector is NOT polarized.

■ Receptacles (Stacking Height=1.5mm)

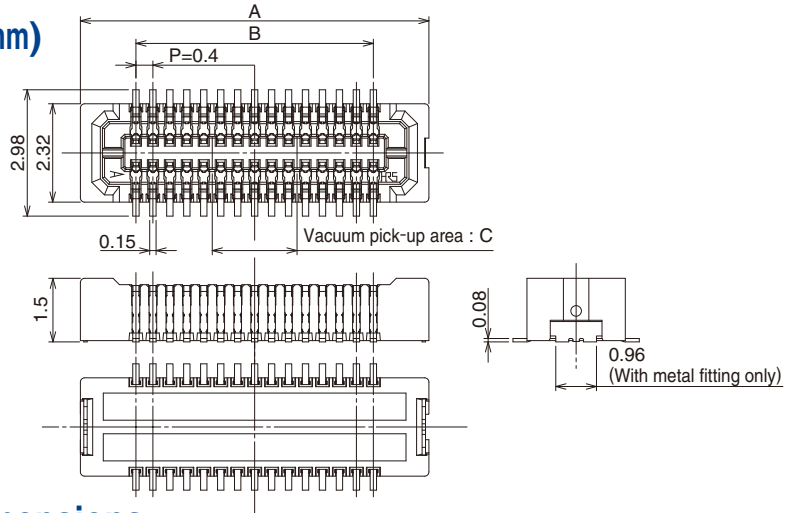
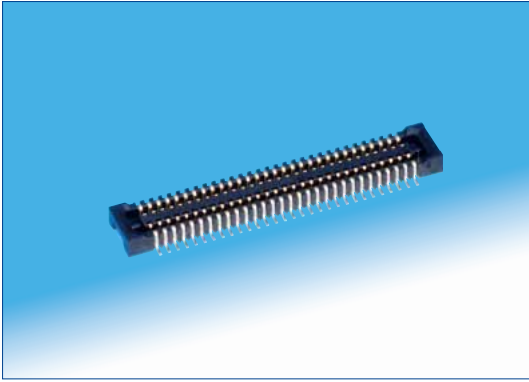

◆ Recommended metal mask dimensions

With metal fittings

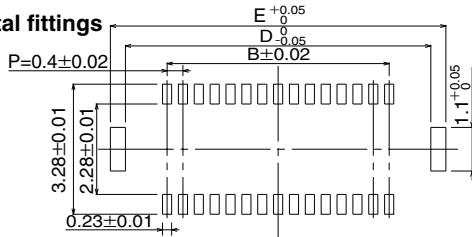

Without metal fittings

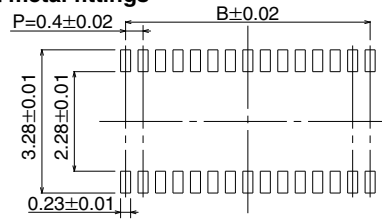

◆ Recommended PCB mounting pattern

With metal fittings

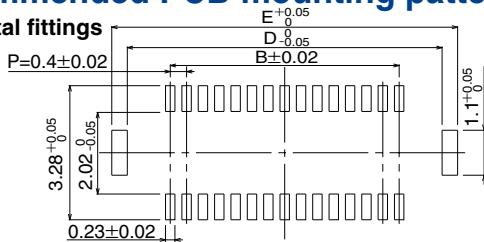

Without metal fittings

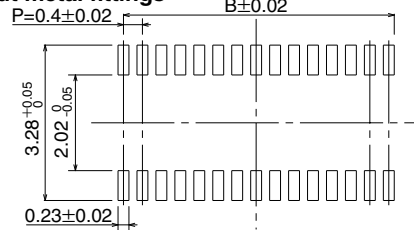

● With metal fittings

Unit : mm

Part No.	HRS No.	No. of Contacts	A	B	C	D	E
DF37NB(1.5)-24DS-0.4V(51)	684-3602-2 51	24	7.02	4.4	2	6.5	7.26

● Without metal fittings

Unit : mm

Part No.	HRS No.	No. of Contacts	A	B	C
DF37NC(1.5)-24DS-0.4V(51)	684-3603-5 51	24	7.02	4.4	2
DF37NC(1.5)-30DS-0.4V(51)	684-3604-8 51	30	8.22	5.6	
DF37NC(1.5)-34DS-0.4V(51)	684-3618-0 51	34	9.02	6.4	2.4
DF37NC(1.5)-40DS-0.4V(51)	684-3606-3 51	40	10.22	7.6	
DF37NC(1.5)-50DS-0.4V(51)	684-3610-0 51	50	12.22	9.6	2.8
DF37NC(1.5)-60DS-0.4V(51)	684-3613-9 51	60	14.22	11.6	3.2
DF37NC(1.5)-70DS-0.4V(51)	684-3614-1 51	70	16.22	13.6	3.6

Note 1 : Tape and reel packaging (5,000 pcs/reel). Order by number of reels.

Note 2 : This connector is NOT polarized.

■ Receptacles (DF37SB)

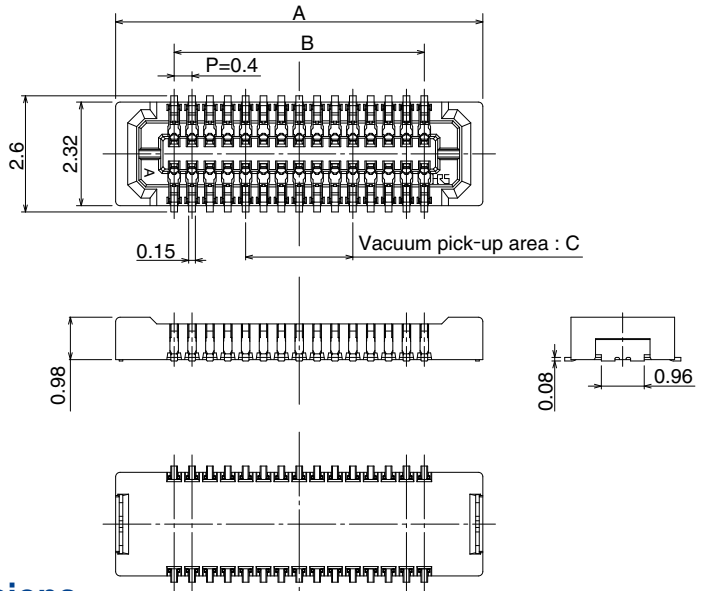
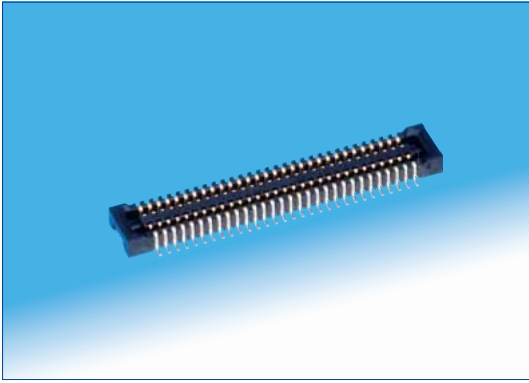

◆ Recommended metal mask dimensions

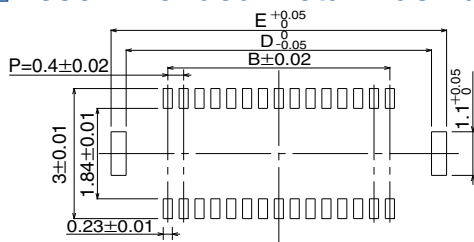

◆ Recommended PCB mounting pattern

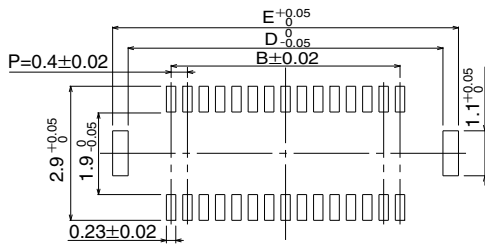

● With metal fittings

Unit : mm

Part No.	HRS No.	No. of Contacts	A	B	C	D	E
DF37SB-20DS-0.4V(51)	684-3502-8 51	20	6.22	3.6	1.6	5.7	6.46
DF37SB-24DS-0.4V(51)	684-3503-0 51	24	7.02	4.4	2	6.5	7.26
DF37SB-30DS-0.4V(51)	684-3504-3 51	30	8.22	5.6		7.7	8.46
DF37SB-34DS-0.4V(51)	684-3505-6 51	34	9.02	6.4	2.4	8.5	9.26
DF37SB-40DS-0.4V(51)	684-3506-9 51	40	10.22	7.6		9.7	10.46
DF37SB-50DS-0.4V(51)	684-3507-1 51	50	12.22	9.6	2.8	11.7	12.46

Note 1 : Tape and reel packaging (8,000 pcs/reel). Order by number of reels.

Note 2 : This connector is NOT polarized.

Headers

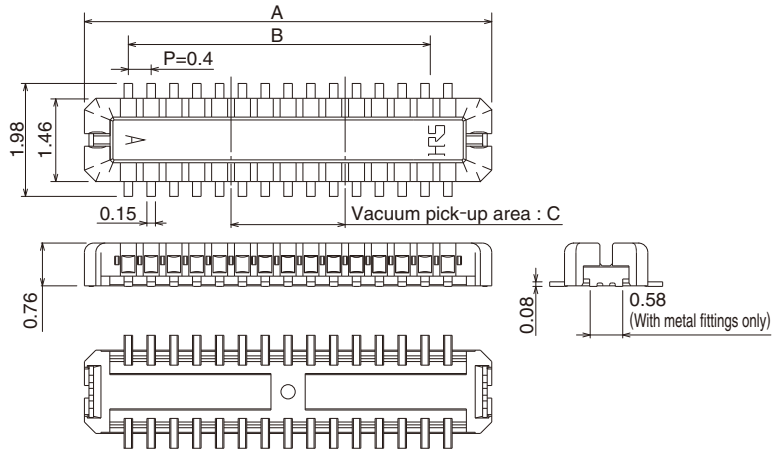
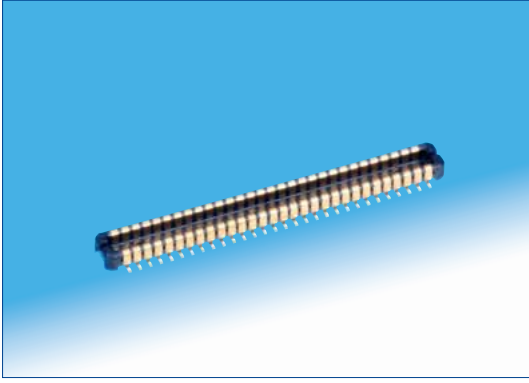

Recommended metal mask dimensions

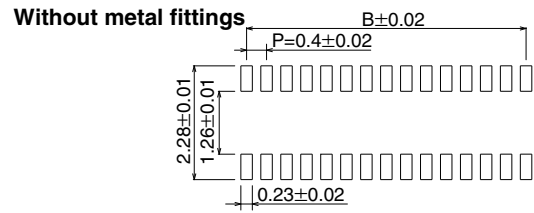
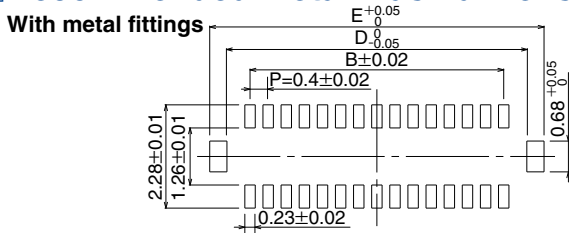

Recommended PCB mounting pattern

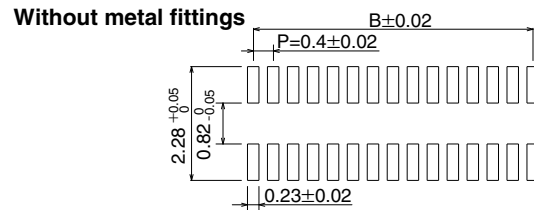
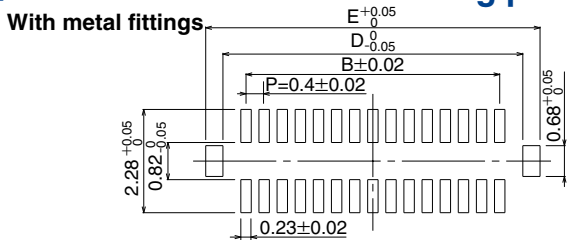

With metal fittings

Unit : mm

Part No.	HRS No.	No. of Contacts	A	B	C	D	E
DF37B-10DP-0.4V(51)	684-3037-0 51	10	3.14	1.6	0.8	2.62	3.38
DF37B-16DP-0.4V(51)	684-3057-7 51	16	4.34	2.8	1.2	3.82	4.58
DF37B-20DP-0.4V(51)	684-3008-1 51	20	5.17	3.6	1.6	4.62	5.38
DF37B-24DP-0.4V(51)	684-3009-4 51	24	5.94	4.4	2	5.42	6.18
DF37B-30DP-0.4V(51)	684-3010-3 51	30	7.14	5.6		6.62	7.38
DF37B-34DP-0.4V(51)	684-3064-2 51	34	7.94	6.4	2.4	7.42	8.18
DF37B-40DP-0.4V(51)	684-3011-6 51	40	9.14	7.6		8.62	9.38
DF37B-44DP-0.4V(51)	684-3408-0 51	44	9.94	8.4	2.8	9.42	10.18
DF37B-50DP-0.4V(51)	684-3012-9 51	50	11.14	9.6		10.62	11.38
DF37B-60DP-0.4V(51)	684-3013-1 51	60	13.14	11.6	3.2	12.62	13.38
DF37B-70DP-0.4V(51)	684-3014-4 51	70	15.14	13.6	3.6	14.62	15.38

Without metal fittings

Unit : mm

Part No.	HRS No.	No. of Contacts	A	B	C
DF37C-10DP-0.4V(51)	684-3039-5 51	10	3.14	1.6	0.8
DF37C-16DP-0.4V(51)	684-3058-0 51	16	4.34	2.8	1.2
DF37C-20DP-0.4V(51)	684-3024-8 51	20	5.17	3.6	1.6
DF37C-24DP-0.4V(51)	684-3025-0 51	24	5.94	4.4	2
DF37C-30DP-0.4V(51)	684-3026-3 51	30	7.14	5.6	
DF37C-34DP-0.4V(51)	684-3085-2 51	34	7.94	6.4	2.4
DF37C-40DP-0.4V(51)	684-3027-6 51	40	9.14	7.6	
DF37C-44DP-0.4V(51)	684-3089-3 51	44	9.94	8.4	2.8
DF37C-50DP-0.4V(51)	684-3028-9 51	50	11.14	9.6	
DF37C-60DP-0.4V(51)	684-3029-1 51	60	13.14	11.6	3.2
DF37C-70DP-0.4V(51)	684-3030-0 51	70	15.14	13.6	3.6

Note 1 : Tape and reel packaging (8,000 pcs/reel). Order by number of reels.

Note 2 : This connector is NOT polarized.

◆ Embossed Carrier Tape Dimensions

● Receptacle (less than 70 positions)

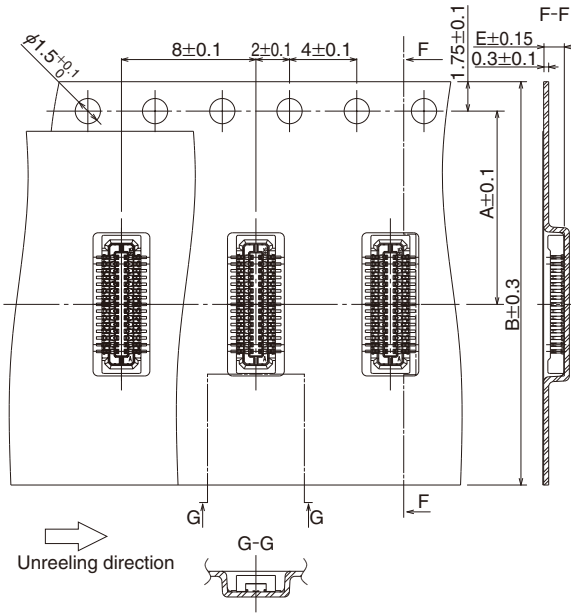

Unit : mm

Part No.	A	B	C	D	E
DF37#(1.5)-24DS-0.4V(51)	7.5	16	17.5	21.5	1.75
DF37#(1.5)-30DS-0.4V(51)					
DF37#(1.5)-34DS-0.4V(51)					
DF37#(1.5)-40DS-0.4V(51)	11.5	24	25.5	29.5	
DF37#(1.5)-50DS-0.4V(51)					
DF37#(1.5)-60DS-0.4V(51)					
DF37#(1.5)-70DS-0.4V(51)	14.2	32	33.5	37.5	

: NB or NC

Tape and reel packaging (5,000 pcs/reel).

● Receptacle (70 positions)

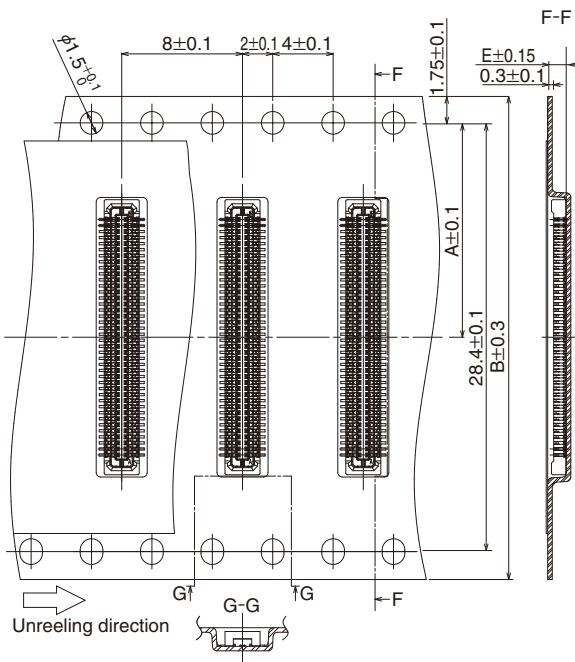

Unit : mm

● Reel Dimensions

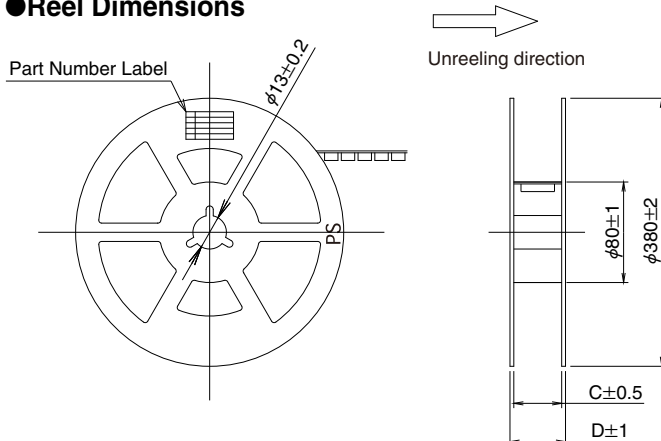

Part No.	A	B	C	D	E
DF37#-10DS-0.4V(51)	7.5	16	17.5	21.5	1.23
DF37#-16DS-0.4V(51)					
DF37#-20DS-0.4V(51)					
DF37#-24DS-0.4V(51)	11.5	24	25.5	29.5	
DF37#-30DS-0.4V(51)					
DF37#-34DS-0.4V(51)					
DF37#-40DS-0.4V(51)					
DF37#-44DS-0.4V(51)					
DF37#-50DS-0.4V(51)					
DF37#-60DS-0.4V(51)					
DF37#-70DS-0.4V(51)	14.2	32	33.5	37.5	

: NB or NC, SB

Tape and reel packaging (8,000 pcs/reel).

◆ Embossed Carrier Tape Dimensions

● Header

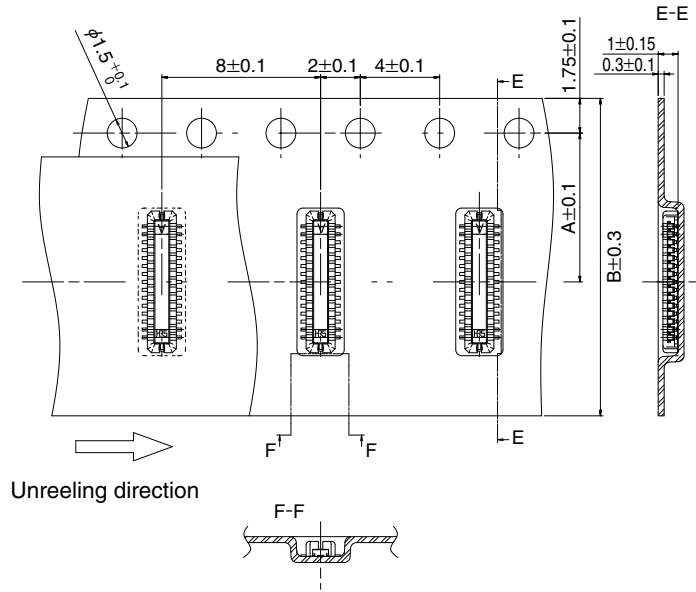

● Reel Dimensions

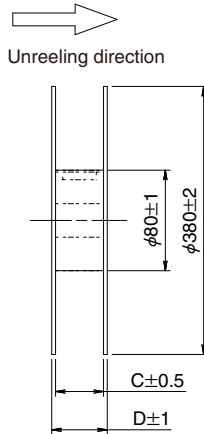
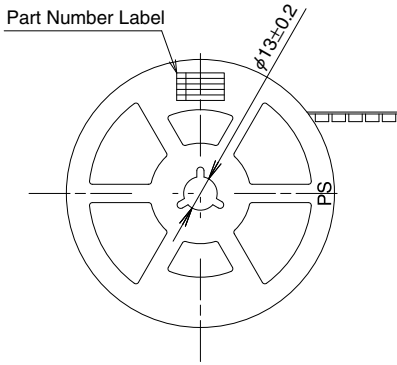

Unit : mm

Part No.	A	B	C	D
DF37#-10DP-0.4V(51)	5.5	12	13.5	17.5
DF37#-16DP-0.4V(51)				
DF37#-20DP-0.4V(51)	7.5	16	17.5	21.5
DF37#-24DP-0.4V(51)				
DF37#-30DP-0.4V(51)				
DF37#-34DP-0.4V(51)				
DF37#-40DP-0.4V(51)				
DF37#-44DP-0.4V(51)	11.5	24	25.5	29.5
DF37#-50DP-0.4V(51)				
DF37#-60DP-0.4V(51)				
DF37#-70DP-0.4V(51)				

: B, C

Tape and reel packaging (8,000 pcs/reel).

◆ Usage Recommendations

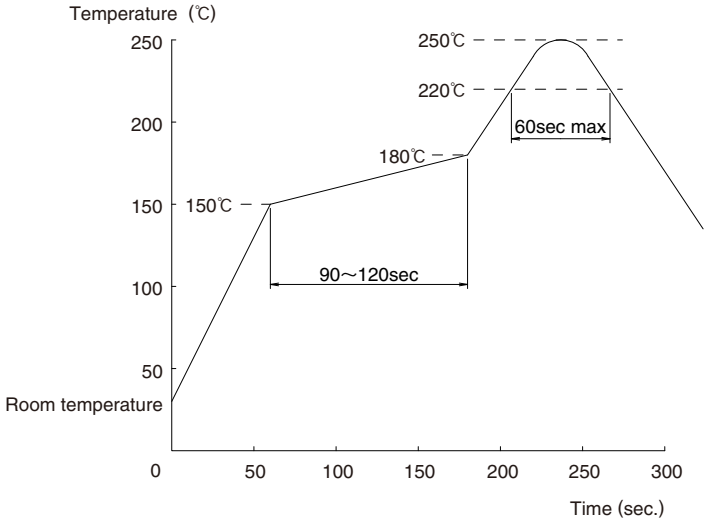
<p>1.Recommended temperature profile</p>	 <p>Note 1: Up to 2 cycles of Reflow soldering are possible under the same conditions, provided that there is a return to normal temperature between the first and second cycle.</p> <p>Note 2: The temperature profile indicates the board surface temperature at the point of contacts with the connector terminals.</p>
<p>2.Recommended manual soldering</p>	<p>Manual soldering : $340\pm 10^{\circ}\text{C}$ for 3 seconds</p>
<p>3.Recommended screen thickness and open area ratio (Pattern area ratio)</p>	<p>Thickness : 0.12mm Open area ratio : Receptacle:80%(NB/NC), Plug : 70%</p>
<p>4.Board warpage</p>	<p>Maximum of 0.02mm at the connector center, with both ends of the connector as reference points.</p>
<p>5.Cleaning conditions</p>	<p>Cleaning is not recommended. When cleaning, please evaluate as it can deteriorate the performance including mechanical operation and environmental resistance.</p>
<p>6.Precautions</p>	<ul style="list-style-type: none"> ■ Mating and un-mating of the connectors when not soldered on the boards is not recommended as this may cause deformation of the terminals, damage to the contacts or insulators. ■ Mated connectors should not carry weight of the board by themselves. Provide some other support of the boards. ■ When mating/un-mating do not twist or lift by the corners. Apply the forces evenly across the entire length and width of the connectors taking care NOT to damage or deform soldered terminations. ■ Exercise extreme caution when mating/ un-mating when the connector is mounted on a nonrigid (flexible) substrate. Slight discoloration on the insulating materials will not affect form, fit or function of the connectors. ■ Do NOT pull on the flexible substrate.

◆ Handling Precautions when Mating Connectors

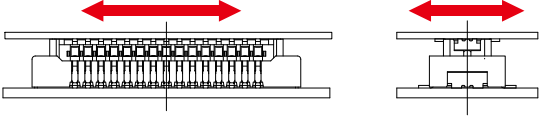
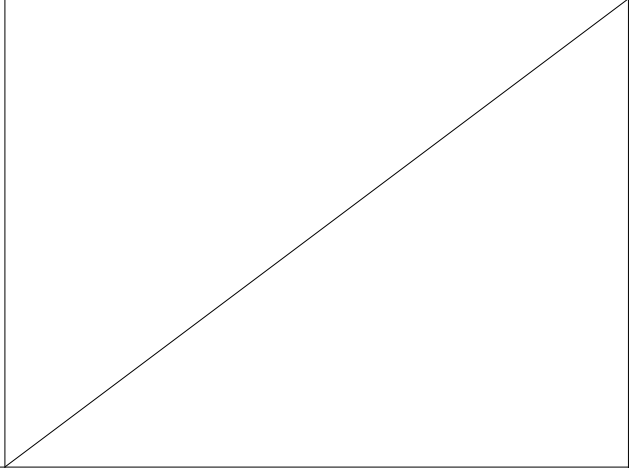
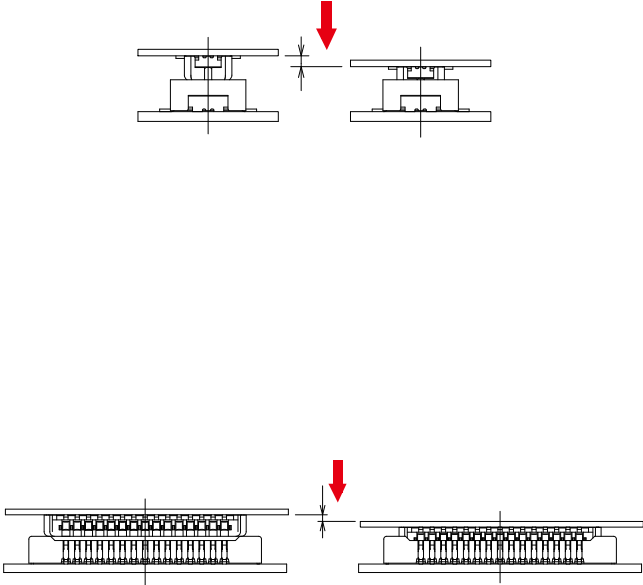
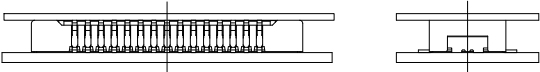
	
	<p>Keep the connectors parallel to each other when positioning. The connectors will self-align in horizontal directions.</p> <p>Do not attempt to mate the connectors starting at one end or side.</p>
	<p>Press-down even until fully mated.</p>

Jun. 1. 2020 Copyright 2020 HIROSE ELECTRIC CO., LTD. All Rights Reserved.

◆ Handling Precautions When Un-mating Connectors

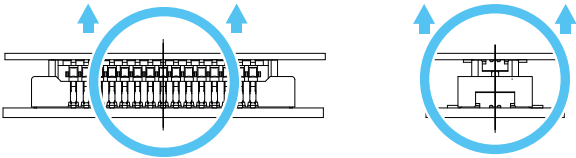
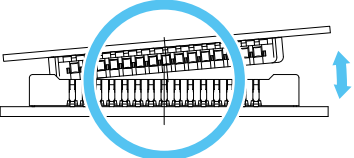
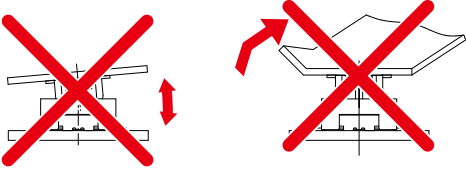
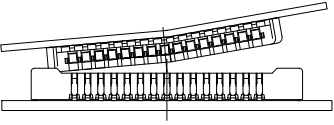
	<p>Lift even, keeping both connectors parallel to each other</p>
	<p>When handling, circumstances may prevent the connectors from being kept parallel when un-mating. One end may be lifted as shown. However, to use this procedure the connector must be mounted on sufficiently rigid circuit board. Any deflection of the board during this operation may result in damage to the connector or solder joints.</p>
	<p>Do not attempt to start the un-mating of the connectors from one side or corner. Failure to exercise caution when un-mating the connectors mounted on the non-rigid FPC may also result in connector breakage. It is the responsibility of the user to perform verification of the repeated mating / un-mating cycles with the connectors mounted on the applicable FPC.</p>
	<p>When the rigidity of the FPC is low, there is a risk that the connector could break as illustrated in the diagram at left. Please use the connectors after performing a check of repeated operation with the FPC that the customer will be using. Evaluative results of FPC rigidity and various items are available. Please inquire.</p>

USA:

HIROSE ELECTRIC (U.S.A.), INC. HEADQUARTERS CHICAGO OFFICE
2300 Warrenville Road, Suite 150,
Downers Grove, IL 60515
Phone : +1-630-282-6700
<http://www.hirose.com/us/>

USA:

HIROSE ELECTRIC (U.S.A.), INC. SAN JOSE OFFICE
2841 Junction Ave, Suite 200
San Jose, CA. 95134
Phone : +1-408-253-9640
Fax : +1-408-253-9641
<http://www.hirose.com/us/>

USA:

HIROSE ELECTRIC (U.S.A.), INC. DETROIT OFFICE (AUTOMOTIVE)
17197 N. Laurel Park Drive, Suite 253,
Livonia, MI 48152
Phone : +1-734-542-9963
Fax : +1-734-542-9964
<http://www.hirose.com/us/>

THE NETHERLANDS:

HIROSE ELECTRIC EUROPE B.V.
Hogehillweg #8 1101 CC Amsterdam Z-O
Phone : +31-20-6557460
Fax : +31-20-6557469
<http://www.hirose.com/eu/>

GERMANY:

HIROSE ELECTRIC EUROPE B.V. GERMAN BRANCH
Schoenbergstr. 20, 73760 ostfildern
Phone : +49-711-456002-1
Fax : +49-711-456002-299
<http://www.hirose.com/eu/>

GERMANY:

HIROSE ELECTRIC EUROPE B.V. NUREMBERG OFFICE
Neumeyerstrasse 22-26, 90411 Nurnberg
Phone : +49-911 32 68 89 63
Fax : +49-911 32 68 89 69
<http://www.hirose.com/eu/>

GERMANY:

HIROSE ELECTRIC EUROPE B.V. HANOVER OFFICE
Bayernstr. 3, Haus C 30855 Langenhagen, Germany
Phone : +49-511 97 82 61 30
Fax : +49-511 97 82 61 35
<http://www.hirose.com/eu/>

FRANCE:

HIROSE ELECTRIC EUROPE B.V. PARIS OFFICE
Regus La Garenne Colombes, Place de La Belgique,
71 Boulevard National La Garenne Colombes, 92250, France
Phone : +33 (0) 1 7082 3170
Fax : +33 (1) 7082 3101
<http://www.hirose.com/eu/>

UNITED KINGDOM:

HIROSE ELECTRIC EUROPE BV (UK BRANCH)
4 Newton Court, Kelvin Drive, Knowlhill,
Milton Keynes, MK5 8NH
Phone : +44-1908 202050
Fax : +44-1908 202058
<http://www.hirose.com/eu/>

CHINA:

HIROSE ELECTRIC (SHANGHAI) CO., LTD.
1601, Henderson Metropolitan, NO.300, East Nanjing
Road, Huangpu District, Shanghai, China 200001
Phone : +86-21-6391-3355
Fax : +86-21-6391-3335
<http://www.hirose.com/cn/>

CHINA:

HIROSE ELECTRIC (SHANGHAI) CO., LTD. BEIJING BRANCH
A1001, Ocean International Center, Building 56# East 4th
Ring Middle Road, ChaoYang District, Beijing, 100025
Phone : +86-10-5165-9332
Fax : +86-10-5908-1381
<http://www.hirose.com/cn/>

CHINA:

HIROSE ELECTRIC TECHNOLOGIES (SHENZHEN) CO., LTD.
Room 09-13, 19/F, Office Tower Shun Hing Square, Di Wang Commercial Centre,
5002 Shen Nan Dong Road, Shenzhen City, Guangdong Province, 518008
Phone : +86-755-8207-0851
Fax : +86-755-8207-0873
<http://www.hirose.com/cn/>

HONG KONG:

HIROSE ELECTRIC HONGKONG TRADING CO., LTD.
Room 1001, West Wing, Tsim Sha Tsui Centre, 66
Mody Road, Tsim Sha Tsui East, Kowloon, Hong Kong
Phone : +852-2803-5338
Fax : +852-2591-6560
<http://www.hirose.com/hk/>

TAIWAN:

HIROSE ELECTRIC TAIWAN CO., LTD.
103 8F, No.87, Zhengzhou Rd., Taipei
Phone : +886-2-2555-7377
Fax : +886-2-2555-7350
<http://www.hirose.com/tw/>

KOREA:

HIROSE KOREA CO., LTD.
250, Huimanggongwon-ro, Siheung-si,
Gyeonggi-do, Korea, 15083
Phone : +82-31-496-7000 or 7124
Fax : +82-31-496-7100
<http://www.hirose.co.kr/>

SINGAPORE:

HIROSE ELECTRIC SINGAPORE PTE. LTD.
10 Anson Road #26-16, International Plaza
079903, Singapore
Phone : +65-6324-6113
Fax : +65-6324-6123
<http://www.hirose.com/sg/>

INDIA:

HIROSE ELECTRIC SINGAPORE PTE. LTD. DELHI LIAISON OFFICE
Office NO.552, Regus-Green Boulevard, Level5, Tower C,
Sec62, Plot B-9A, Block B, Noida, 201301, Uttar Pradesh, India
Phone : +91-12-660-8018
Fax : +91-120-4804949
<http://www.hirose.com/sg/>

INDIA:

HIROSE ELECTRIC SINGAPORE PTE. LTD. BANGALORE LIAISON OFFICE
Unit No-403, 4th Floor, No-84, Barton Centre, Mahatma
Gandhi (MG) Road, Bangalore 560 001, Karnataka, India
Phone : +91-80-4120 1907
Fax : +91-80-4120 9908
<http://www.hirose.com/sg/>

MALAYSIA:

PENANG REPRESENTATIVE OFFICE
1-21-01, Suntech @ Penang Cybercity (1164), Lintang
Mayang Pasir 3,11950, Bayan Baru, Penang, Malaysia.
Phone : +604-619-2564
Fax : +604-619-2574
<http://www.hirose.com/sg/>

THAILAND:

BANGKOK OFFICE (REPRESENTATIVE OFFICE)
Unit 4703, 47th FL., 1 Empire Tower, South Sathorn
Road, Yannawa, Sathorn, Bangkok 10120 Thailand
Phone : +66-2-686-1255
Fax : +66-2-686-3433
<http://www.hirose.com/sg/>

**HIROSE ELECTRIC CO., LTD.**

2-6-3, Nakagawa Chuoh, Tsuzuki-Ku, Yokohama-Shi 224-8540, JAPAN
TEL: +81-45-620-3526 Fax: +81-45-591-3726
<http://www.hirose.com>
<http://www.hirose-connectors.com>